

Model No.DC18RE FAST CHARGER SET

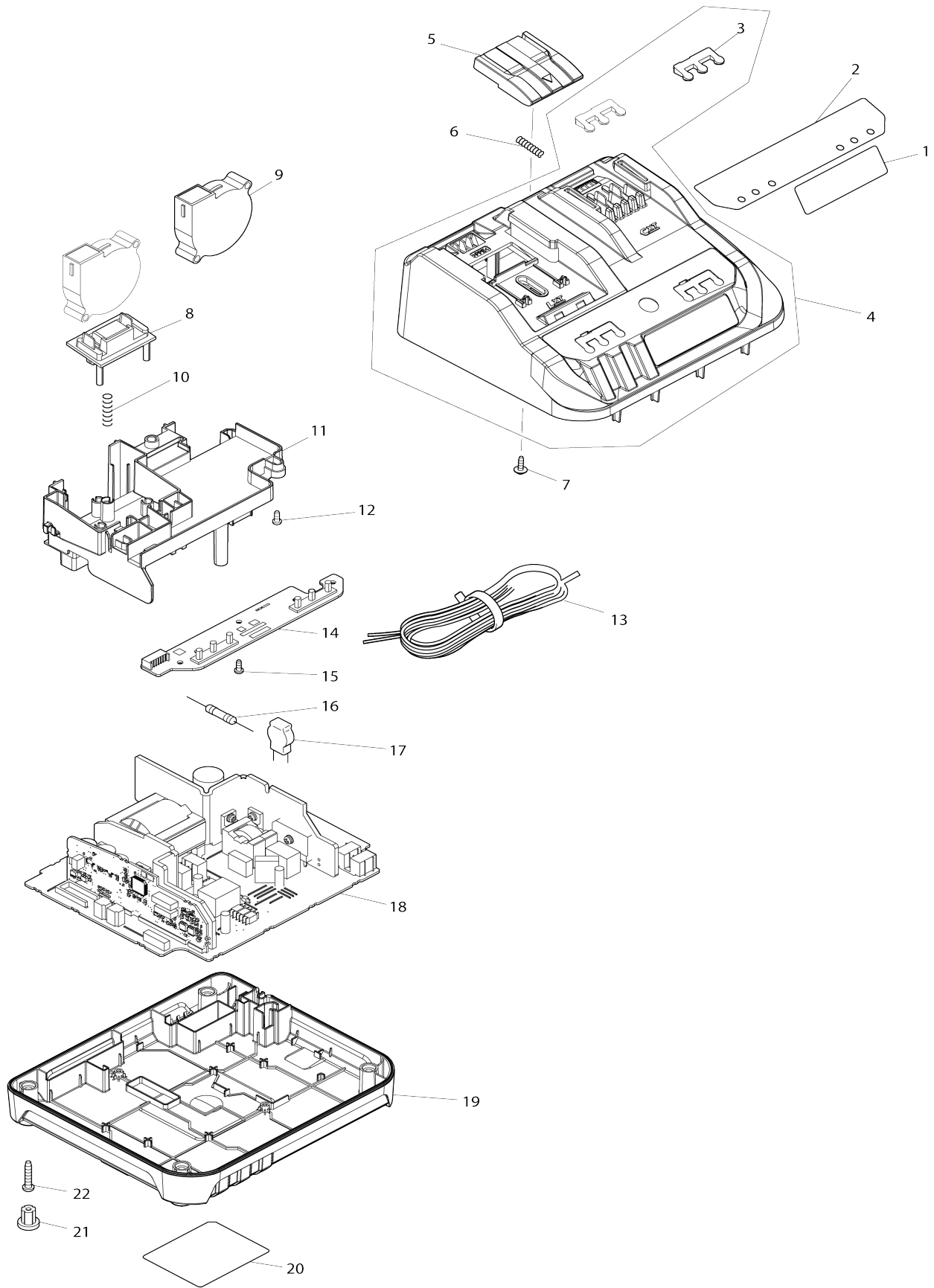

Model No.DC18RE FAST CHARGER SET

Item No.	Parts No.	Description	Interchangability	Q'ty	New/Old	Note1	Note2
001	812P95-5	Makita logo label		1			
002	812P94-7	Charging condition label		1			
003	457693-8	Lens		2			
004	144562-9	Charger case complete (black)		1			
D10		INC. 3					
005	457692-0	Terminal cover (blue)		1			
006	231474-6	COMPRESSION SPRING 4		2			
007	266278-7	TAPPING SCREW FLANGE BT3X10		1			
008	632K43-6	Terminal unit		1			
009	638499-5	SCIROCCO FAN		2			
010	233194-8	COMPRESSION SPRING 4		1			
011	457691-2	Terminal base		1			
012	266764-8	TAPPING SCREW 3X8		4			
013	667985-9	VINYL CORD 0.75-2-2.0		1			
014	620692-5	Led circuit		1			
015	266764-8	TAPPING SCREW 3X8		3			
016	652802-6	FUSE		1			
017	647306-1	VARISTOR		1			
018	620681-0	Charging circuit		1			
D10		INC. 16,17					
019	457690-4	Charger case cover (black)		1			
020	854G61-2	DC18RE NAME PLATE		1			
021	286255-3	CAP 13		4			
022	266426-8	TAPPING SCREW 4X20		4			

Please state Parts No. when your order.

Print Date 05/24/2024