

Model No.DC10WD BATTERY CHARGER

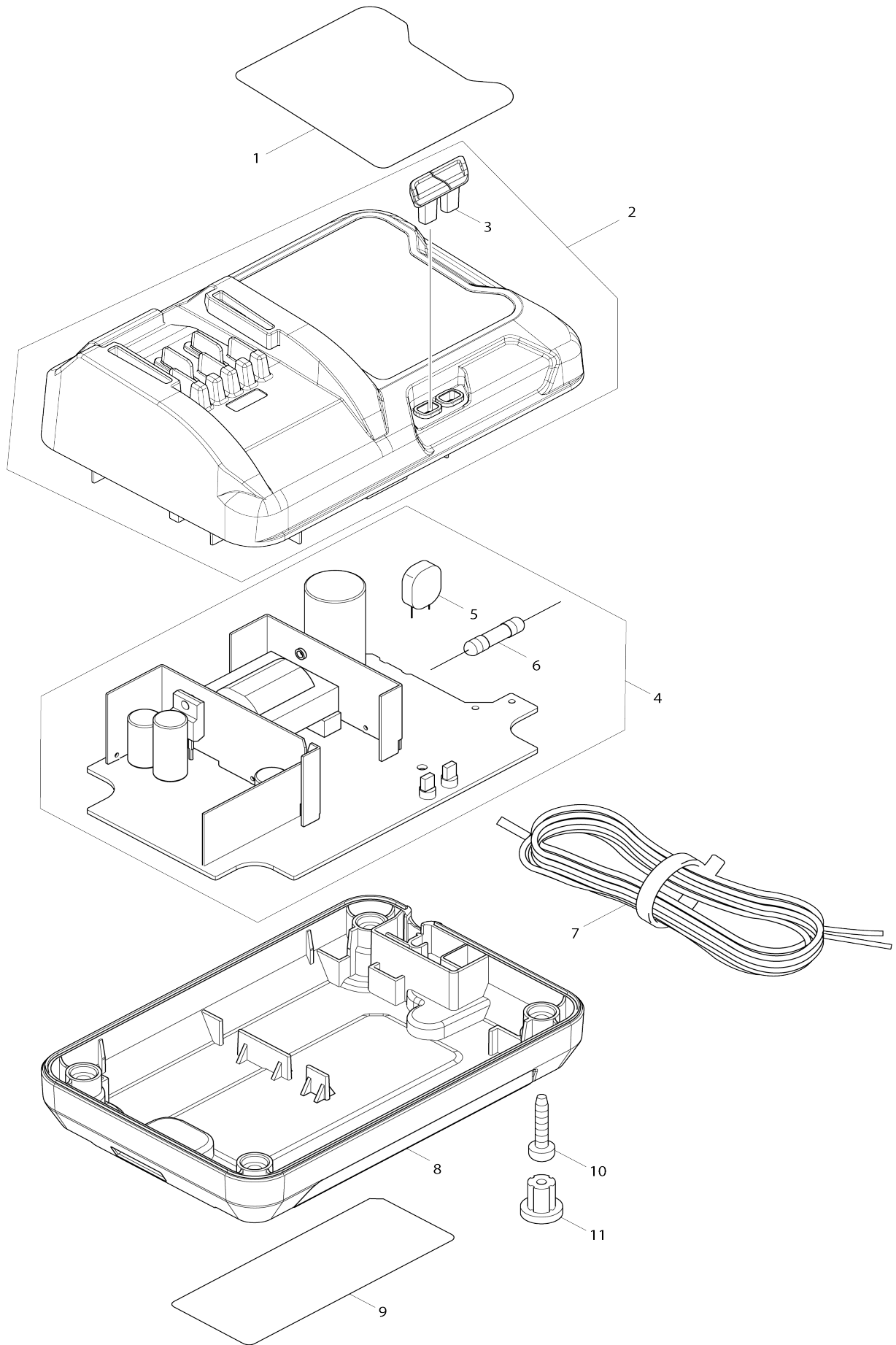

Model No.DC10WD BATTERY CHARGER

Item No.	Parts No.	Description	Interchangability	Q'ty	New/Old	Note1	Note2
001	807B57-2	CHARGING CONDITION LABEL		1			
002	143244-0	CHARGER CASE COMPLETE		1			
D10		INC. 3					
003	455959-0	LENZ		1			
004	620421-6	CHARGING CIRCUIT		1			
D10		INC. 5,6					
005	647306-1	VARISTOR		1			
006	652804-2	FUSE		1			
007	667985-9	VINYL CORD 0.75-2-2.0		1			
008	455958-2	CHARGER CASE COVER		1			
010	266346-6	TAPPING SCREW BT 4X20		4	*		
010-1	265B01-9	TAPPING SCREW PT 4X20	<	4			
011	286255-3	CAP 13		4			
F06	197343-0	DC10WD BATTERY CHARGER SET		1			
F12	191B50-9	DC10WD BATTERY CHARGER SET		1			
A01	456128-6	BATTERY COVER		1			
A02	197396-9	BATTERY BL1021B SET		1			

Please state Parts No. when your order.

Print Date 05/24/2024