

Model No.ADP001G ADAPTER FOR USB

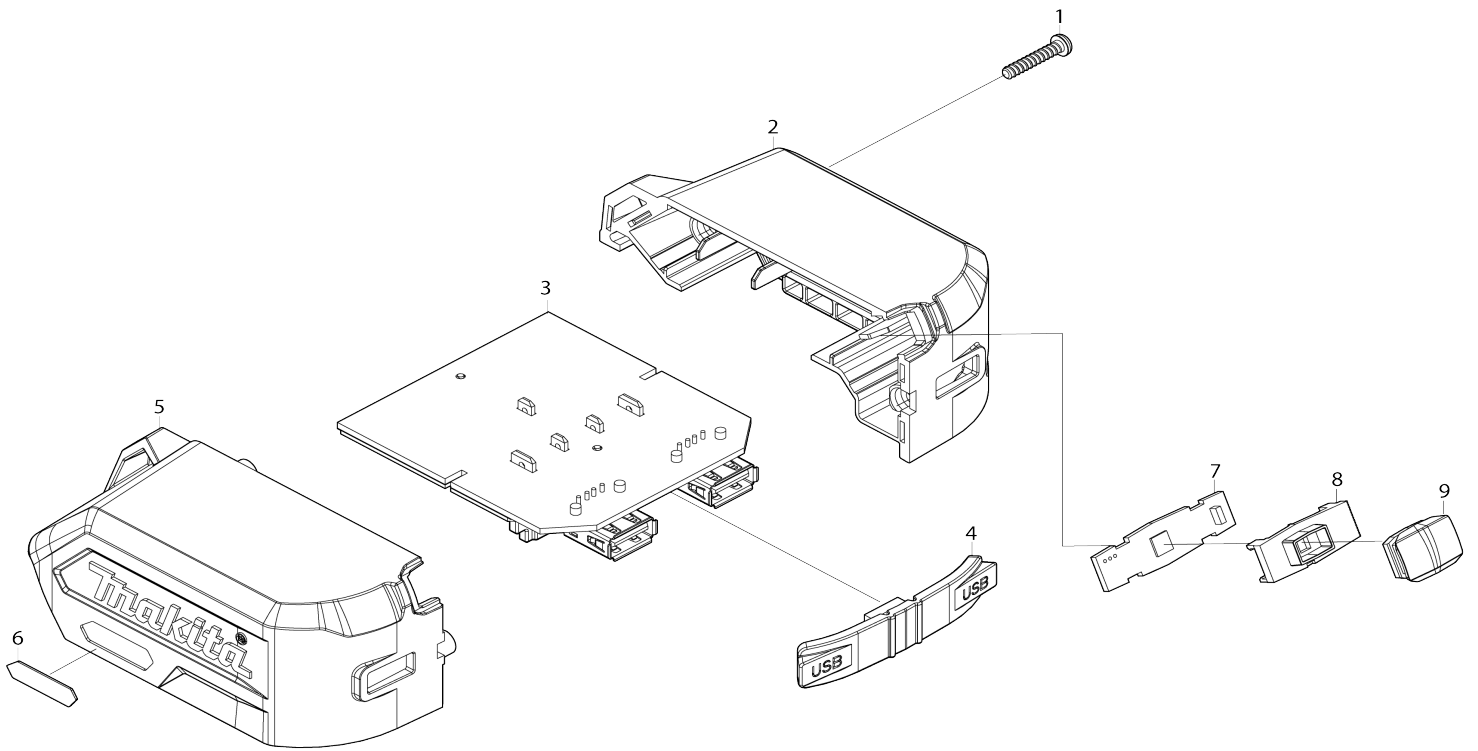

Model No.ADP001G ADAPTER FOR USB

Item No.	Parts No.	Description	Interchangability	Q'ty	New/Old	Note1	Note2
001	SE00000834	SCREW PTP 3X16(ZK)		2			
002	SE00000835	HOUSING SET		1			
D10		INC. 5					
003	SE00000836	PCB A ASS'Y		1			
004	SE00000837	USB COVER		1			
005	SE00000835	HOUSING SET		1			
D10		INC. 2					
006	SE00000838	XGT PLATE		1			
007	SE00000839	PCB C ASS'Y		1			
008	SE00000840	LED LENS		1			
009	SE00000841	POWER BUTTON		1			

Please state Parts No. when your order.

Print Date 05/06/2024