

Model No.DC1414 CHARGER

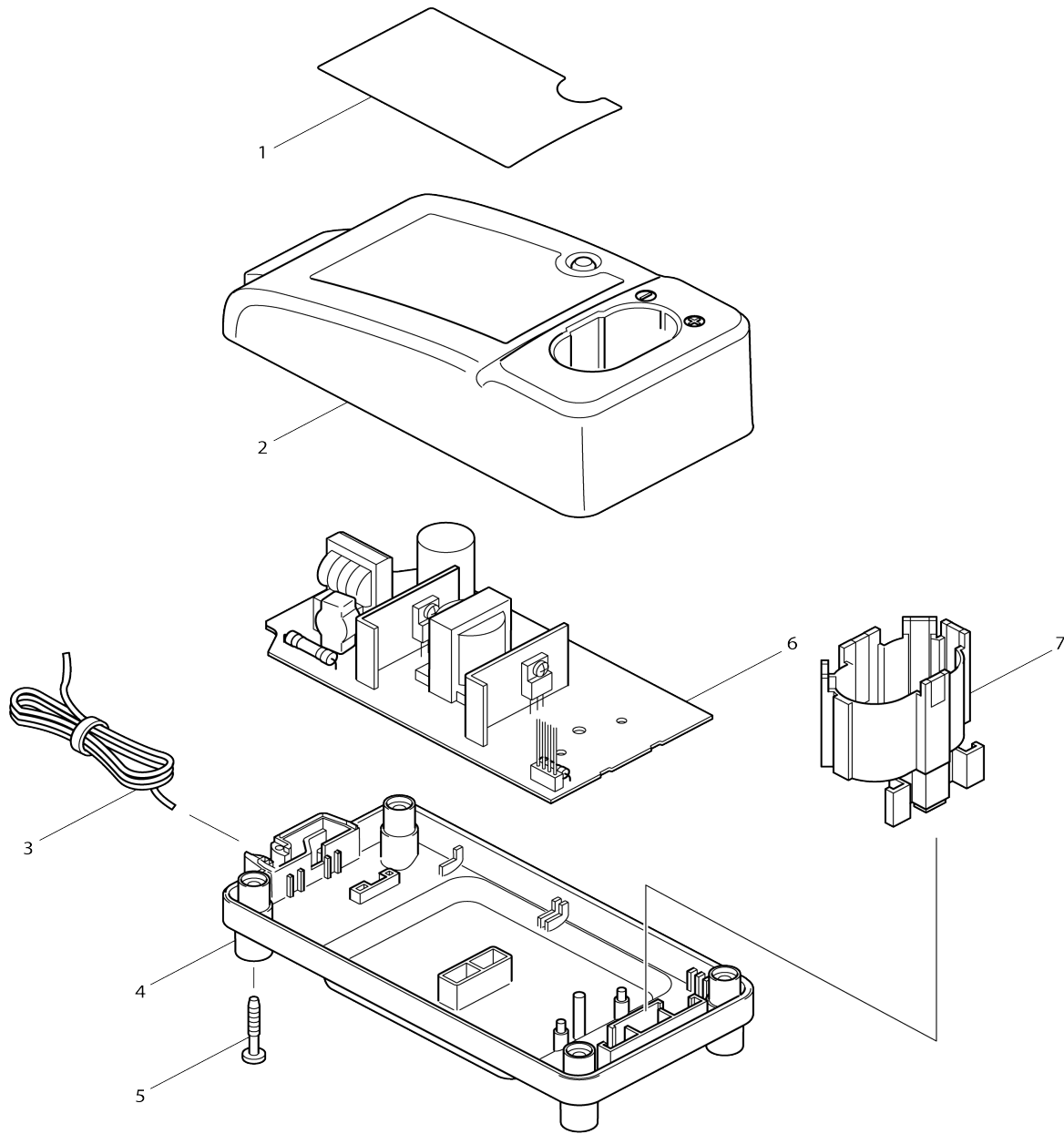

Model No.DC1414 CHARGER

Item No.	Parts No.	Description	Interchangability	Q'ty	New/Old	Note1	Note2
001	850977-7	NAME PLATE DC1414		1	*		
001-1	861121-1	NAME PLATE DC1414T	X	1			
001A_	861107-5	NAME PLATE DC1414F		1			
002	153743-4	CHARGER CASE COMPLETE		1			
002A_	154439-0	CHARGER CASE COMPLETE		1	*		
003	667985-9	VINYL CORD 0.75-2-2.0		1			
003A_	667822-7	VINYL CORD 0.75-2-2.0		1	*		
003A1	667985-9	VINYL CORD 0.75-2-2.0	O	1			
004	418339-1	CHARGER CASE COVER		1			
004A_	418346-4	CHARGER CASE COVER		1	*		
005	265999-8	TAPPING SCREW 4X25		4	*		
005-1	266355-5	TAPPING SCREW BT 4X25	O	4	*		
005-2	265B08-5	TAPPING SCREW PT 4X25	<	4			
005A_	266350-5	TAPPING SCREW 3.5X25		4	*		
006	631584-3	CIRCUIT BOARD		1	*		
C10	647306-1	VARISTOR		1	*		
C20	652747-8	FUSE 250V 2.5A		1	*		
006-1	631623-9	CIRCUIT BOARD	<	1			
C10	647306-1	VARISTOR		1			
C20	652747-8	FUSE 250V 2.5A		1	*		
C21	652780-0	FUSE	O	1	*		
C22	652805-0	FUSE	>	1			
006A_	631633-6	CIRCUIT BOARD		1	*		
C10	647326-5	VARISTOR		1	*		
C20	652773-7	FUSE 250V 2.5A		1	*		
007	418477-9	BATTERY BOX		1			
007A_	418650-1	BATTERY BOX		1	*		
F01-1	193864-0	DC1414 BATTERY CHARGER SET	O	1			
F23	194151-0	DC1414 BATTERY CHARGER SET		1			

Please state Parts No. when your order.

Print Date 05/24/2024