

Model No.DC1439 FAST CHARGER

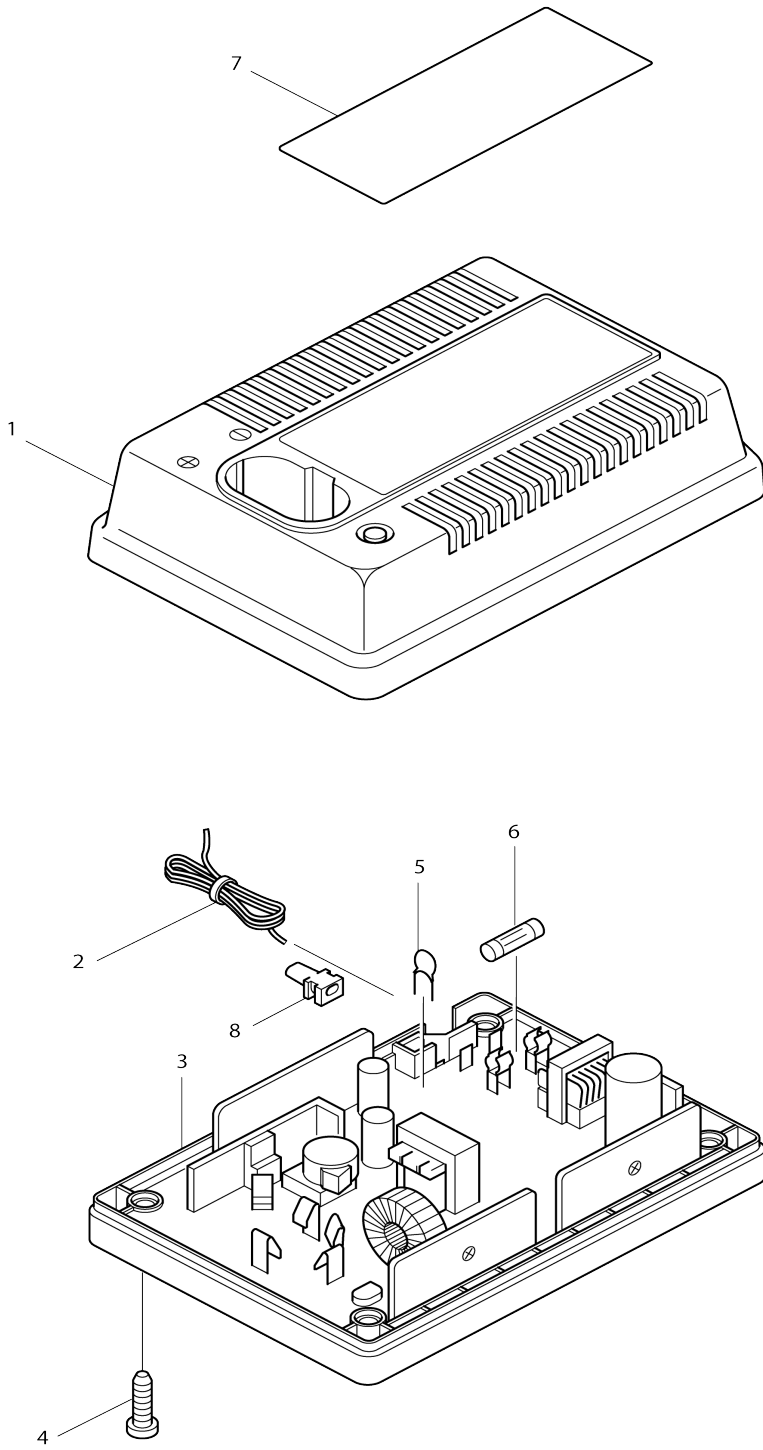

Model No.DC1439 FAST CHARGER

Item No.	Parts No.	Description	Interchangability	Q'ty	New/Old	Note1	Note2
001	151606-8	Charger case complete (blue)		1			
002A_	667957-4	Power supply cord 0.75-2-2.0		1	*		
002A1	667841-3	Power supply cord 0.75-2-2.0	O	1	*		
002A2	667849-7	Power supply cord 0.75-2-2.0	<	1			
003	632902-8	Charging circuit complete		1	*		
D10		INC. 5,6					
003-1	638395-7	Charging circuit complete	O	1			
D10		INC. 5,6					
004	265874-8	TAPPING SCREW BT 4X20		4	*		
004-1	266408-0	Pan head BT tapping screw 4X20	O	4			
005	647304-5	VARISTOR		1	*		
005-1	647327-3	VARISTOR	<	1			
006	652724-0	Fuse		1	*		
006-1	652777-9	Fuse	<	1			
007	851658-6	Name plate DC1439		1	*		
007-1	861968-3	Name plate DC1439	<	1			
008	682525-2	CORD GUARD		1			

Please state Parts No. when your order.

Print Date 05/24/2024