

Model No.DC18WA CHARGER

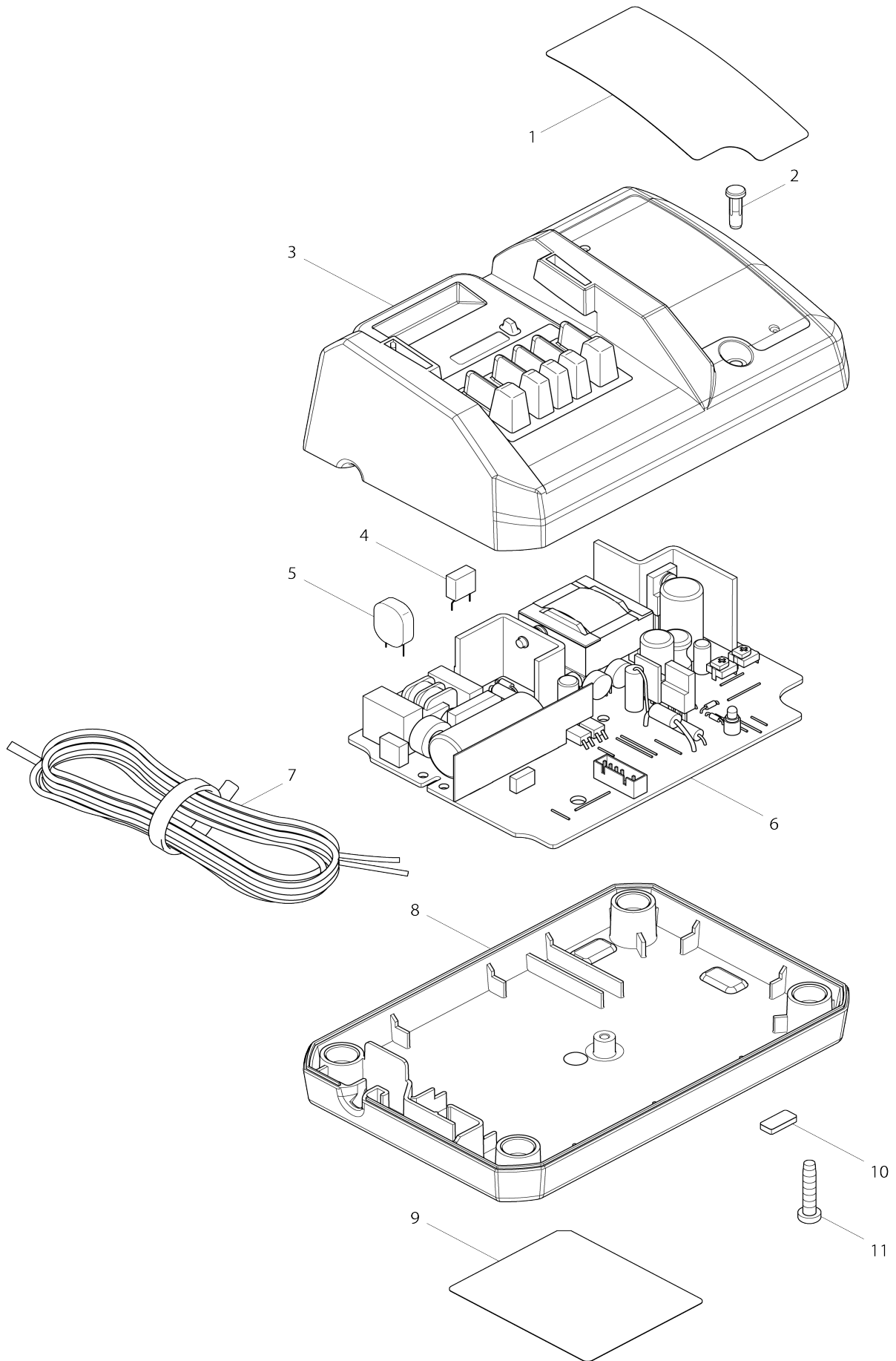

Model No.DC18WA CHARGER

Item No.	Parts No.	Description	Interchangability	Q'ty	New/Old	Note1	Note2
001	892431-5	CHARGING CONDITION LABEL		1			
002	452263-8	LENS		1	*		
002A_	454956-3	LENS		1			
003	140825-1	CHARGER CASE COMPLETE		1	*		
D10		INC. 2					
003A_	142456-2	CHARGER CASE COMPLETE		1			
D10		INC. 2A					
004	652789-2	FUSE		1	*		
004-1	652789-2	FUSE	O	1			
005	647333-8	VARISTOR		1	*		
005-1	647306-1	VARISTOR	O	1			
006	620026-2	CHARGING CIRCUIT		1	*		
D10		INC. 4,5					
006A_	620272-7	CHARGING CIRCUIT		1			
007	667869-1	POWER SUPPLY CORD		1	*		
007-1	667985-9	VINYL CORD 0.75-2-2.0	O	1			
007A_	667895-0	POWER SUPPLY CORD		1	*		
007A1	667985-9	VINYL CORD 0.75-2-2.0	O	1			
008	140713-2	CHARGER CASE COVER COMPLETE		1	*		
D10		INC. 10					
008A_	142453-8	CHARGER CASE COVER COMPLETE		1			
D10		INC. 10A					
009	869026-9	DC18WA NAME PLATE		1			
010	423415-8	RUBBER SHEET		6			
010A_	423474-2	RUBBER SHEET		6			
011	266625-2	TAPPING SCREW PT 4X20		4			
011A_	266897-9	TAPPING SCREW PT 4X20		4			
F08-1	195423-6	DC18WA BATTERY CHARGER SET	<	1			

Please state Parts No. when your order.

Print Date 05/24/2024